

An Experimental Problem of a Competition Discussed in a Secondary School Workshop

Péter Vankó

Institute of Physics, Budapest University of Technology and Economics, Budapest, Hungary

Abstract

A difficult experimental problem of a Hungarian competition (selecting competition for IPhO) and different methods for analyzing the experimental results are presented. It is demonstrated, that the background and the solution of this optical problem can be nice discussed by simple computer programs in a secondary school workshop.

1 Introduction

Inventing an experimental problem for a competition is not an easy job: the problem should be interesting, not widely known and solvable in a few hours; the apparatus (a lot of uniform copies) should be simple and cheap. Experimental setups of earlier competitions are therefore valuable for physics teachers.

They are widely used for preparing students for other competitions: to solve experimental problems is the best way to practice experimental techniques, data analysis and error estimation.

The apparatus of an experimental problem can be also used for smaller local competitions, where originality is not so important.

Nice experimental problems of competitions are excellent not only for competitors, but for inquiring students as measuring exercises. In most secondary school there is not enough time and a well-equipped physics lab to arrange measurements for students. The Institute of Physics at the Budapest University of Technical Engineering organizes for ten years the experimental round of the National Schools Competition in physics. By using the experimental setups of these competitions measuring exercises are announced for secondary school students. The students make the same measurements and solve the same problems as the competitors, but with the help of a tutor.

The fourth suggestion for using an experimental problem is a secondary school workshop. In a workshop inquiring students and teachers can solve and discuss the problem together. In contrast to the competitors the participants of the workshop have more time, can work together, can use PC software's and can learn more about the mathematical and physical background of the problem.

In this paper a nice and difficult optical problem of a Hungarian competition (selecting competition for IPhO) and different methods for analyzing the experimental results are presented. The practical and theoretical difficulties of the problem are shown and the possibility of a detailed discussion (without advanced mathematics - but with the help of simple PC software's) in a secondary school workshop is demonstrated.

2 The experimental problem¹

There are two optical structures to investigate by semiconductor laser. Both of them are multiple slits, i.e. a few parallel and identical transparent slits on a dark background separated by the same distance. From the diffraction pattern of the laser beam determine the distance, the number and the width of the slits in both optical structures.

Apparatus

- A photo detector (in a black plastic box), i.e. a circuit contains a photodiode, a battery and a resistor. The output voltage of the photo detector is proportional to the intensity of the light falling on the photodiode.
- A digital multimeter to measure voltage.
- A semiconductor laser.
- The optical structures in a frame.
- Aluminum blocks to fix the frame.
- A measuring tape, a ruler, adhesive tape.



Procedure

- Fix the ruler to the table by adhesive tape. Beside the ruler you can move the photo detector and measure its position. Connect the detector to the multimeter.
- Put the laser about 1 m from the detector and direct the beam into the photodiode. Adjust the laser to reach a maximum output voltage (about 9 V).
- Place one of the slit structures into the beam direct before the laser and fix the frame by the aluminum blocks.
- Move gently the detector in both direction and measure how the diffracted light intensity changes with position.
- Plot the diffraction pattern of both slit structures, i.e. a graph of relative light intensity against diffraction angle.
- Determine the distance of the slits for both structures.
- Determine the number of the slits for both structures.
- Determine the width of the slits for both structures.

The wavelength of the laser is $650 \text{ nm} \pm 1\%$.

¹ It was the first experimental problem of the Fényes Competition (Hungarian Selecting Competition for IPhO), Sopron, Hungary, 9th May 1998. The time available was 2 hours. The problem was invented and assembled by Gyula Honyek (ELTE Radnóti Miklós Gymnasium, Budapest) and the author.

3 The solution of the problem expected at the competition

3.1 The difficulties of the measurement

The careful adjusting of the arrangement is very important. If the laser beam does not directed to the center of the photodiode, the intensity decreases and the small maxima of the diffraction pattern can not be detected. The slit structure must be centered into the beam, too.

The whole diffraction pattern is only a few cm and the small maxima are separated only by 2 – 2.5 mm, so the detector position should be read at least with half a mm accuracy.

The light intensity at the small maxima is only a few percent of the intensity at the middle of the pattern, so for an accurate reading it is necessary to change the measurement range of the voltmeter during the measurement.

For the correct estimation of the relative intensities, it is important to measure the background light intensity and subtract it from the measured data.

An additional error is that the dark background of the optical structures is not absolute black. The light intensity vs. position can be measured, when the laser beam cross the dark region, but the correction of the measured data with this pattern was not expected at the competition.

3.2 Measured data

The plots of measured data for both slit structures are shown in two different magnifications in *Fig. 1* and *Fig. 2*.

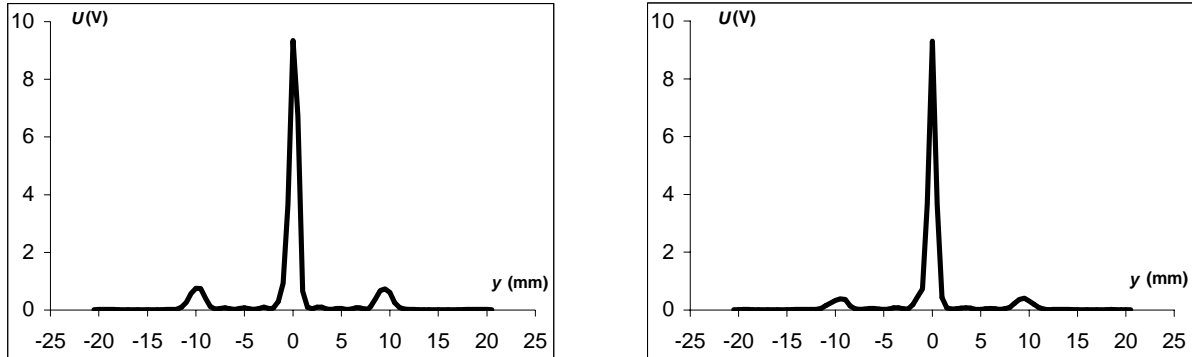

Fig. 1

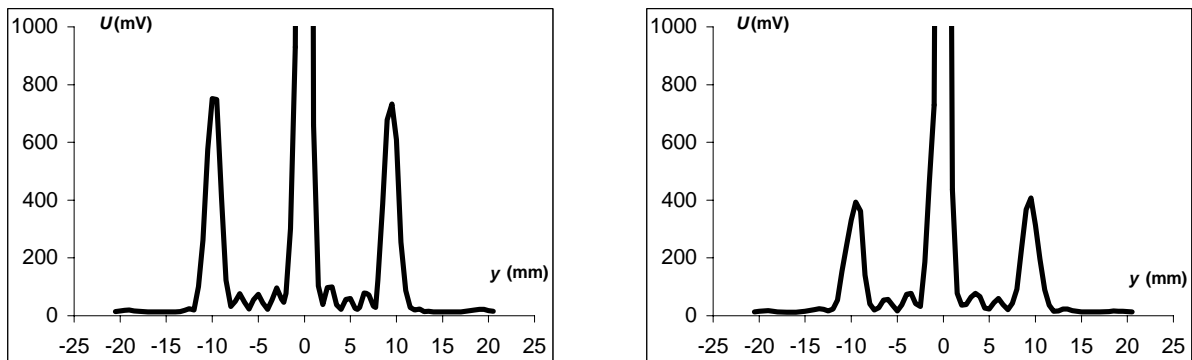

Fig. 2

The data can be corrected with the background light intensity (measured without laser beam) and related to the main maximum as shown in *Fig. 3*.

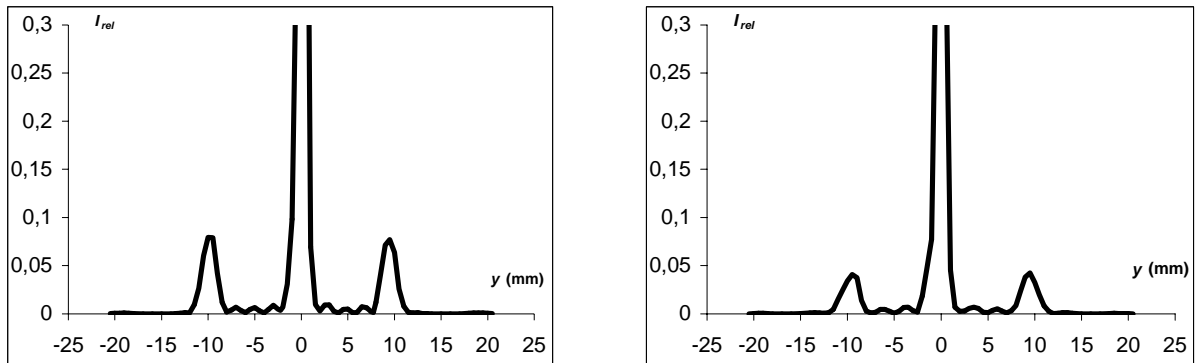

Fig. 3

A second correction can be made by subtracting the intensity vs. position data measured as the laser beam crosses the (not absolute black) background of the slit structures. These data (thick line) compared with one of the slit structures (narrow line) are shown in *Fig. 4*. For the solution of the experimental problem the corrected graphs shown in *Fig. 5* are to be interpreted.

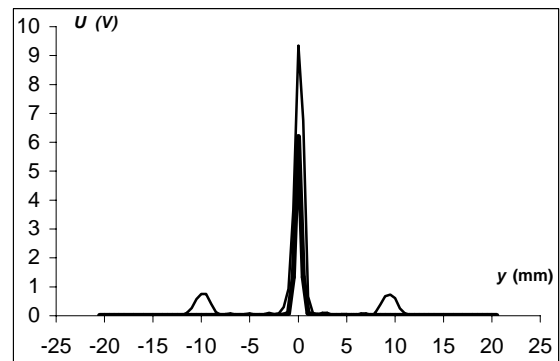

Fig. 4

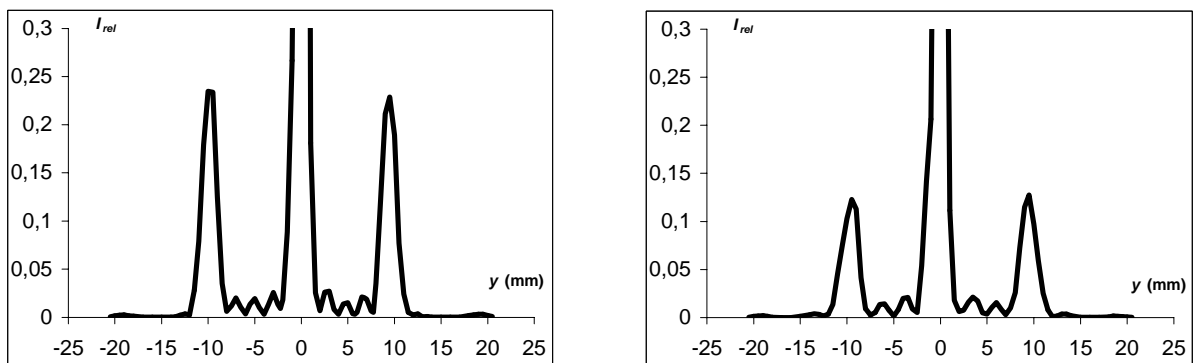

Fig. 5

3.3 Interpretation of the measured data

3.3.1 Determination of the distance between neighboring slits

This part of the problem is the easiest, most competitors could solve it. The notation and some simple equation used for the problem are shown in *Fig. 6*.

The condition for the first big maximum can be derived in the same way as for the double slit or for the grating. If the phase difference between two neighboring slits is 2π the diffracted rays from different slits increase each other.

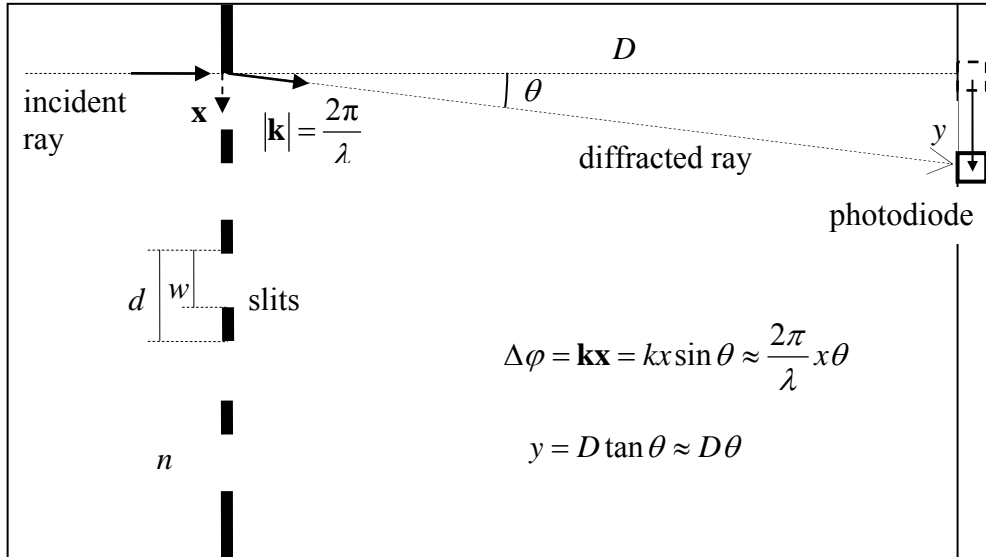

Fig. 6

From this follows the well known result:

$$\frac{\lambda}{d} = \sin \theta \approx \theta \quad (\text{with } \theta \ll 1),$$

$$y = D \tan \theta \approx D\theta \approx D \frac{\lambda}{d}.$$

This expression gives the exact position of the first maximum if $w \ll d$. It is not true for the investigated slit structures, but the difference is less than 3 %.

The position of the first big maximum can be read from the measured and corrected data shown in *Fig. 5*. The peaks are between 9.5 and 10.0 mm for both structures. From this

$$y = 9.75 \pm 0.25 \text{ mm}$$

Used the measured value of $D = 1 \text{ m}$ (with 0.5 % accuracy) and the given value of λ the separation of the slits is

$$d = D \frac{\lambda}{y} = \mathbf{67 \pm 3 \mu\text{m}}$$

for both slit structures.

3.3.2 The number of slits

The number of slits (n) can be determined from the number of small maxima (or from the number of zeros) between two neighboring big maxima. The relationship can be understood by phasors, i.e. vectors expressing phase (and amplitude). Phasors are used in the secondary school to represent voltages and currents in AC circuits, for example.

The rays from neighboring slits reach the photodiode with a phase difference of

$$\varphi = \frac{2\pi}{\lambda} d\theta,$$

so the phasors represent the resultant \mathbf{E}_1 vectors of the light from a single slit are twisted with this angle relative to each other. The light intensity is proportional to the square of the (vectorial) sum of the phasors.

The sum of n phasors with the same length and twisted with the same $\varphi < 2\pi$ angle relative to each other can be zero if

$$\varphi = m \frac{2\pi}{n},$$

where m is an integer and $0 < m < n$ (see Fig. 7 for $n = 5$). Since m has $n-1$ different values there are $n-1$ zeros between two neighboring big maxima and therefore there are $n-2$ small maxima.

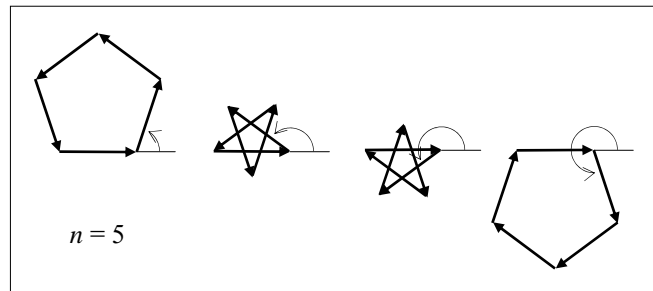

Fig. 7

Therefore the number of slits is $n = 5$ in the first structure and $n = 4$ in the other one.

3.3.3 Determining the (relative) width of the slits

This is the most sophisticated part of the problem. An estimation had been expected, but nobody could solve this part at the competition. To determine the exact width of the slits a detailed analysis of the phasor diagram is necessary, but it is easier to realize, that the relative width w/d can be neither too small nor too big.

If $w \ll d$ the phasors represent the resultant \mathbf{E}_1 vector of a single slit would not decrease (or decrease very slowly) with increasing θ and at $\varphi = 2\pi$ the sum of the phasors would be the same as at $\varphi = 0$. This would mean that the intensity of the first big maximum is the same (or similar) as the central main maximum.

If $w/d \approx 1$, the slit structure would behave as an n -times wider single slit. A wider slit would have a narrower diffraction pattern without (or with very small) maxima beyond the central main maximum.

If w/d is not very small the phasors represent the resultant \mathbf{E}_1 vector of a single slit can decrease rapidly with increasing θ (because of the interference between rays crossing the same slit). In Fig. 8 the phasor diagram of a multiple slit is shown with $n = 5$ and $w/d = 0.625$ at $\theta = 0$. The amplitude of \mathbf{E}_1 vector is proportional to the width of the slit. If $C = 1$ is chosen for this factor the intensity of the central main maximum can be expressed.

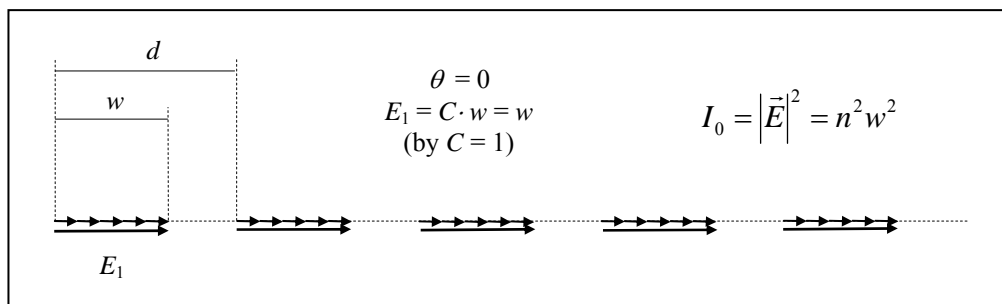

Fig. 8

In *Fig. 9* the phasor diagram of the same multiple slit is shown at $\theta > 0$. The phase difference is increasing with the distance x and the small phasor components form an arc. The radius R has the unit of \mathbf{E} . The length of the arc does not change, so R decreases with increasing θ . The resultant \mathbf{E}_1 vector of a single slit is the chord of the arc. The light intensity I is proportional to the square of the total resultant \mathbf{E} vector.

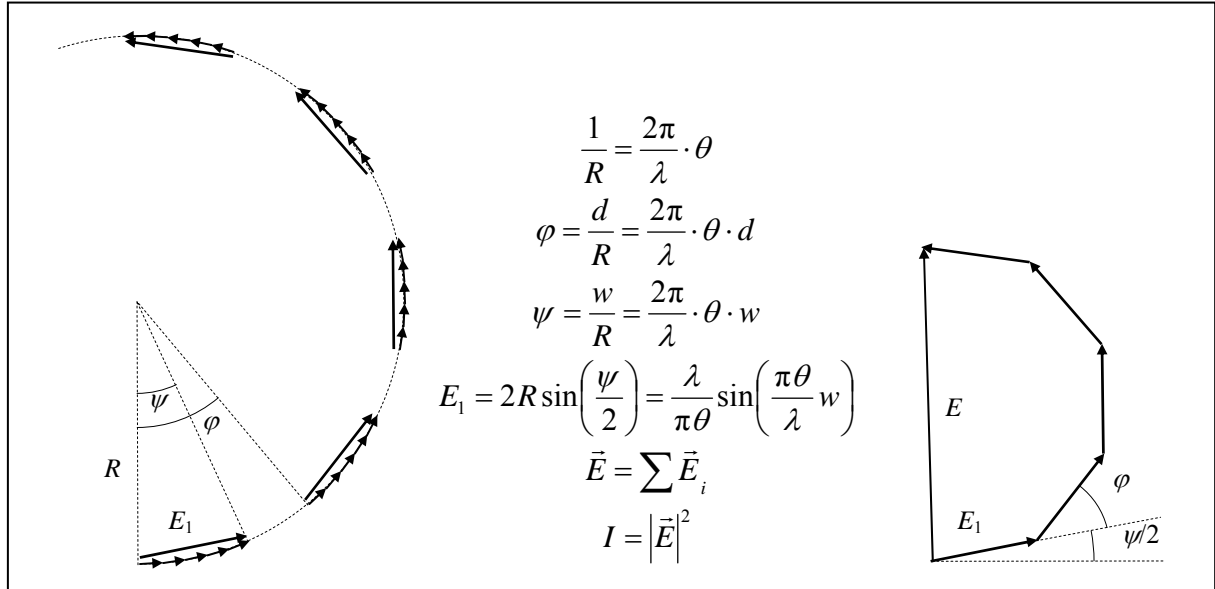

Fig. 9

In *Fig. 10* the change of the total resultant \mathbf{E} is demonstrated for the same multiple slit ($n = 5$, $w/d = 0.625$) at increasing θ . The zeros are similar observable as in *Fig. 7*, but from this figure the intensities of the maxima can be determined, as well.

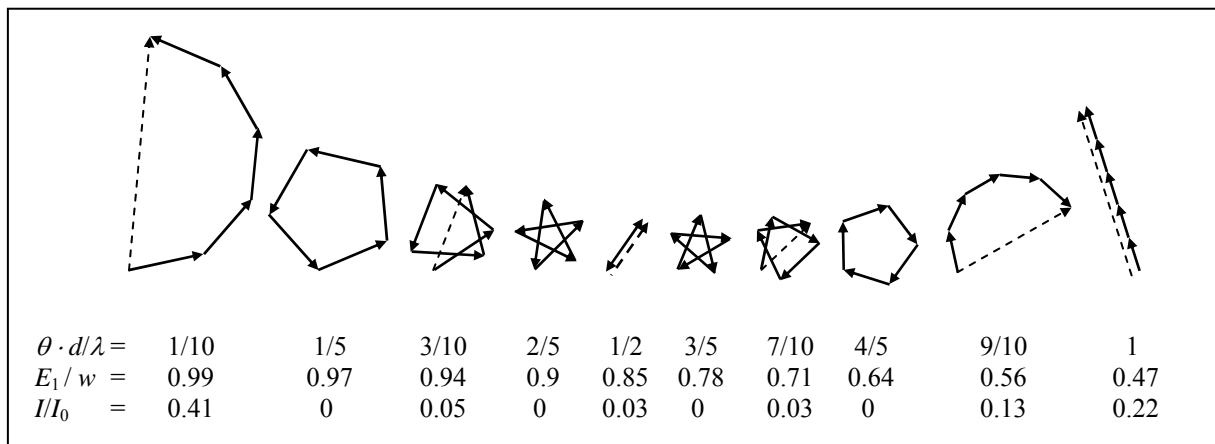

Fig. 10

The relative intensity of the first big maximum (shown in the last phasor diagram; the maximum appears not exactly at this angle but the difference is small) can be calculated by the equations shown in *Fig. 8* and *Fig. 9*:

$$I_{rel} = \frac{I}{I_0} = \left(\frac{d}{w\pi}\right)^2 \sin^2\left(\frac{w\pi}{d}\right).$$

From the measured and corrected data the relative intensity of the first big maximum is about 0.25 for the first structure and about 0.15 for the other one. These results correspond to $w/d = 0.6$ and $w/d = 0.7$ respectively. To estimate the error of relative intensities first of all the inaccurate measured intensity of the central maximum must be considered. The correction with the pattern shown in Fig. 4 is only approximate.

If the intensity of the second big maximum is also investigated a more accurate determination of w/d is possible. In Fig. 11 the phasor diagrams of two slit structures with different w/d value are shown at $\varphi = 2\pi$ and at $\varphi = 4\pi$ (at the first and at the second big maxima). At $\varphi = 2\pi$ there is only a small difference in the magnitude of the \mathbf{E}_1 vectors between the different structures, but at $\varphi = 4\pi$ the difference become more visible. Where $w/d = 0.5$ the second big maximum disappears ($E_1 = 0$).

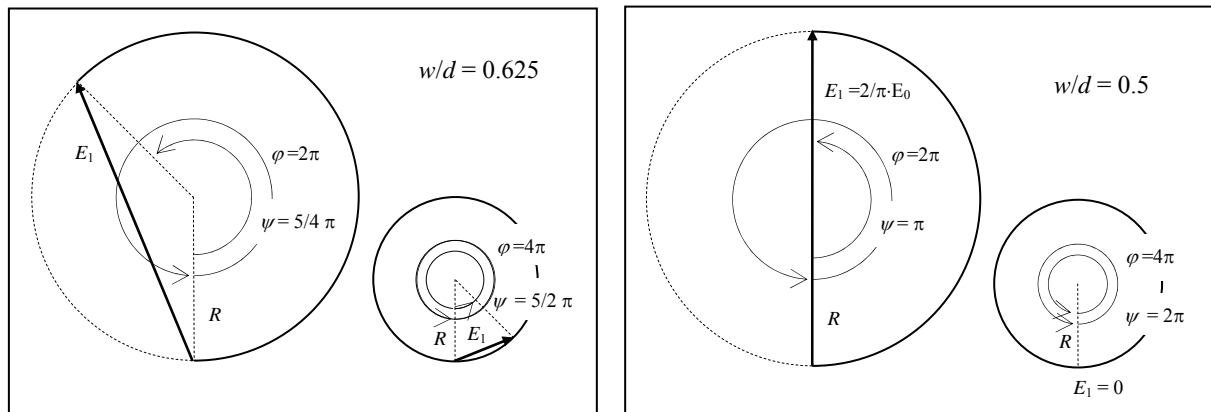

Fig. 11

The relative intensity of the second big maxima compared to the intensity of the first big maxima are very small (about one percent) for both measured slit structure. Therefore w/d can not be significant different from 0.5.

Considered both argumentations the best result for the relative width of the slits is

$$w/d \approx 0.55 \pm 0.05$$

for both structures.

4 Demonstration and discussion of the problem in a secondary school workshop²

4.1 The concept of the workshop

The secondary school workshop is an afternoon event for inquiring students and teachers where an interesting problem is performed and discussed. The participation is voluntary; the approach of the problem is interdisciplinary and free from the syllabus. In the workshop there is enough time to learn about the mathematical and physical background, to perform nice experiments and make measurements, to analyze the data by PC software's and

² The workshop was held in the Árpád Gymnasium (secondary school), Budapest, Hungary, 12th January 2000. The mathematical background (Fourier-integral) was introduced by István Mezei (Eötvös Loránd University, Budapest). The measurement, the solution of the problem and the computer simulation was presented by the author.

to discuss the details and the consequences of the problem. It is not only for students but for colleagues, to learn some new ideas from each other.

Besides performing and discussing this nice experiment the workshop was held to propagate the advantages of the interdisciplinary approach and to demonstrate the use of simple PC software's for solving and analyzing problems, which are in the secondary school mathematical too difficult.

As a mathematical background the principles of Fourier-series and the Fourier-integral were introduced (without mathematical exactness). The experimental problem, the diffraction of light on a multiple slit was presented as a physical realization of this mathematical construction. It was only mentioned that the diffraction pattern could be calculated by Fourier-integral, but the proof and the solution (see the *Appendix*) were not shown.

4.2 The solution and discussion of the experimental problem in the workshop

After discussing the difficulties the measurement was carried out as it is suggested in the text of the problem (*Chapter 2*). In contrast to the competition the participants worked together and the measured data was plotted by Microsoft Excel software (the worksheet and the graph was prepared, the measured data could be typed immediately). [1]

For the interpretation of the measured data the phasor representation was introduced in a similar way as in *Chapter 3*. By means of phasor representation the relative intensity I_{rel} can be calculated without the solution of the Fourier-integral. Plotting the calculated values of the relative intensity I_{rel} vs. detector position y the diffraction pattern for a given multiple slit structure (with given n , d and w values) can be simulated and the simulated pattern can be compared with the measured one. This is the most important possibility of the workshop.

In a Microsoft Excel worksheet the calculation and the plotting can be made easily. As it is shown in *Fig. 9*

$$E_1 = \frac{\lambda}{\pi\theta} \sin\left(\frac{\pi\theta}{\lambda} w\right),$$

$$\vec{E} = \sum \vec{E}_i,$$

$$I = |\vec{E}|^2.$$

The sum of the vectors (*Fig. 12*) can be calculated by means of vector components:

$$I = |\vec{E}|^2 = E_1^2 \left[(1 + \cos\varphi + \cos 2\varphi + \dots + \cos(n-1)\varphi)^2 + (\sin\varphi + \sin 2\varphi + \dots + \sin(n-1)\varphi)^2 \right],$$

where

$$\varphi = \frac{2\pi}{\lambda} \theta d.$$

For plotting the relative intensity vs. the detector position:

$$I_{rel} = \frac{I}{I_0} = \frac{I}{n^2 w^2}$$

and

$$y = D \tan \theta \approx D\theta.$$

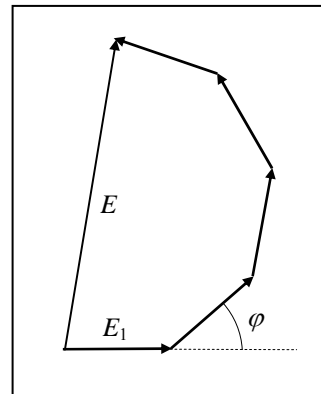

Fig. 12

Using these equations a table is filled out and plotted [2]. By changing the parameters n , d and w/d the graph also changes and can be compared with measured data. The influence of the number of slits (n) on the graph is visible at once. Increasing the value of the distance of the slits (d) moves the position of the maxima to the left. Therefore the value of d can be easily found by comparison, too. Changing the value of the relative width of the slits (w/d) influences the intensity of the maxima. The best agreement between the simulated and measured graph can be found after “playing” with this parameter.

The best fits are shown in *Fig. 13* and *Fig. 14*. The values of the parameters are in agreement with the results determined in *Chapter 3*.

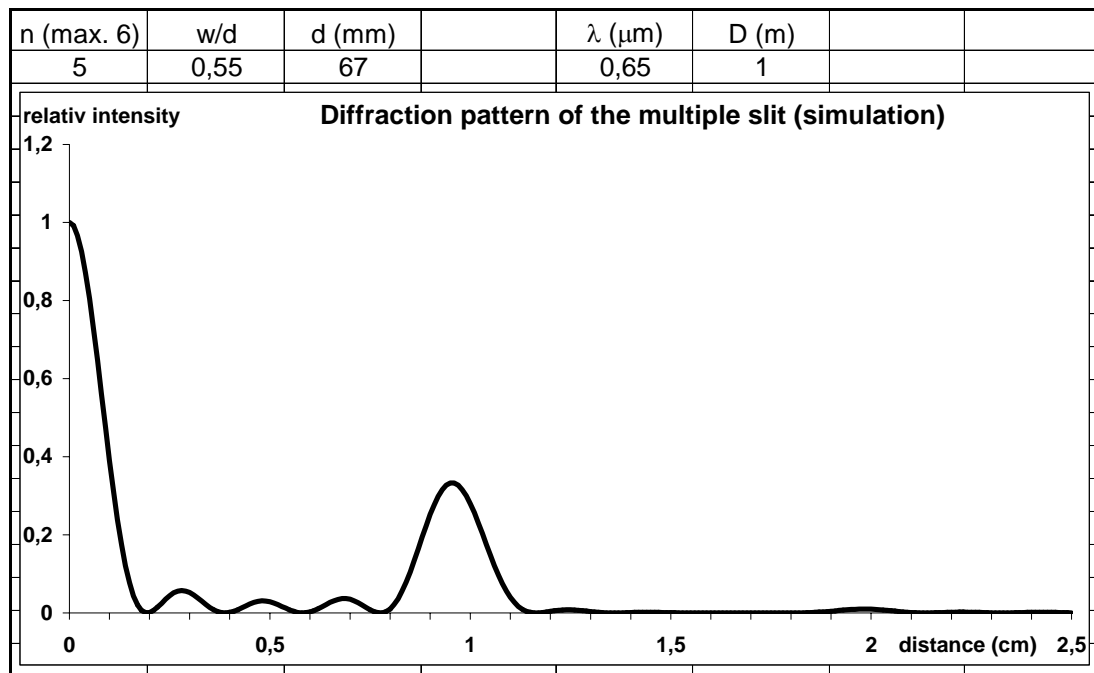

Fig. 13

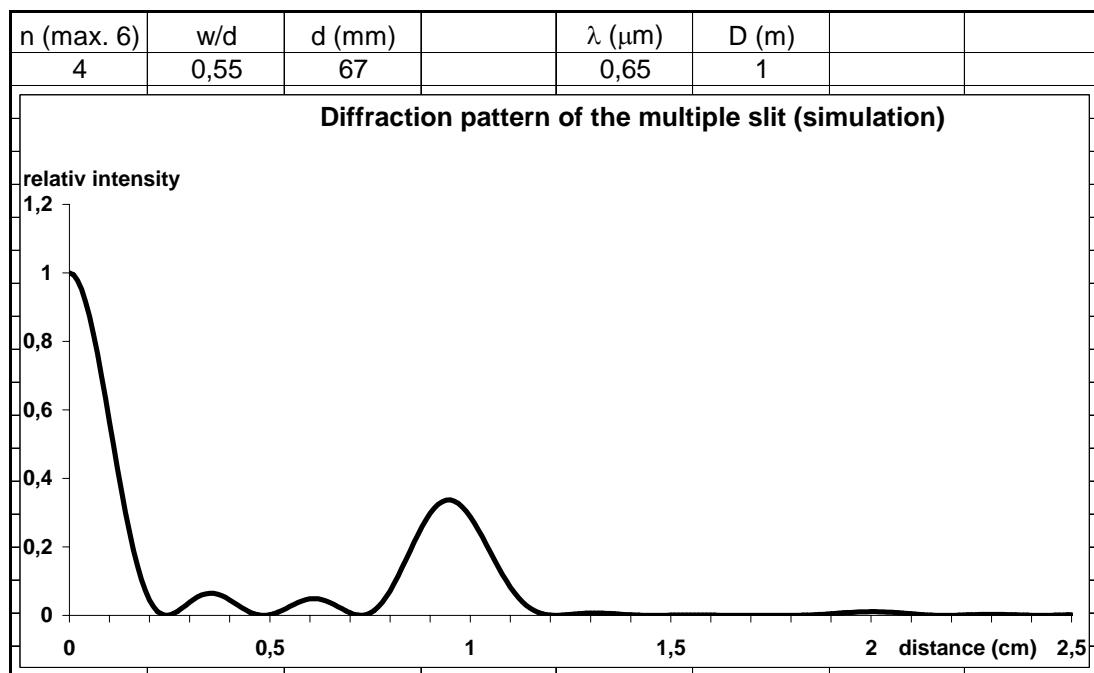

Fig. 14

As the best values were found the participants could play with the apparatus and the simulation. Playing with the parameters not only makes possible to find the result of the experimental problem but helps to understand diffraction on a multiple slit much better. The apparatus, measured data and simulations can be used later for physics lessons, too. But the most important effect of the workshop that perhaps its free atmosphere and interdisciplinary approach could arouse some participants' interest in physics.

5 Appendix

Calculation of the intensity function $I(\theta)$ by Fourier-integral

$$I(\mathbf{k}) = \left| \int_{-\infty}^{\infty} \exp(\mathbf{kx}) f(x) dx \right|^2,$$

$$\text{where } |\mathbf{k}| = k = \frac{2\pi}{\lambda},$$

$$\mathbf{kx} = kx \sin \theta \approx kx\theta \quad (\theta \ll 1),$$

$$f(x) = \begin{cases} 1 & \text{if } x \in [md; w + md] \quad m = 0, 1, \dots, n-1 \\ 0 & \text{else} \end{cases}.$$

$$I(\theta) = \left| \int_{-\infty}^{\infty} \exp(kx\theta i) f(x) dx \right|^2 = \left| \sum_{m=0}^{n-1} \int_{md}^{w+md} \exp(kx\theta i) dx \right|^2 =$$

$$= \left| \sum_{m=0}^{n-1} \frac{\exp(kmd\theta i) (\exp(kw\theta i) - 1)}{k\theta i} \right|^2 = \left| \frac{\exp(kwd\theta i) - 1}{k\theta i} \cdot \frac{\exp(knd\theta i) - 1}{\exp(kd\theta i) - 1} \right|^2 =$$

$$= \left| \frac{\exp\left(\frac{k}{2}w\theta i\right) \frac{\exp\left(\frac{k}{2}w\theta i\right) - \exp\left(-\frac{k}{2}w\theta i\right)}{2i} \cdot \exp\left(\frac{k}{2}nd\theta i\right) \frac{\exp\left(\frac{k}{2}nd\theta i\right) - \exp\left(-\frac{k}{2}nd\theta i\right)}{2i}}{\frac{k\theta i}{2i} \cdot \exp\left(\frac{k}{2}d\theta i\right) \frac{\exp\left(\frac{k}{2}d\theta i\right) - \exp\left(-\frac{k}{2}d\theta i\right)}{2i}} \right|^2 =$$

$$= \left| \frac{\exp\left[\frac{k}{2}(w+nd-d)\theta i\right] \sin\left(\frac{k}{2}w\theta\right) \cdot \sin\left(\frac{k}{2}nd\theta\right)}{\frac{k\theta}{2} \cdot \sin\left(\frac{k}{2}d\theta\right)} \right|^2 =$$

$$= \frac{\sin^2\left(\frac{k}{2}w\theta\right) \cdot \sin^2\left(\frac{k}{2}nd\theta\right)}{\frac{k^2\theta^2}{4} \cdot \sin^2\left(\frac{k}{2}d\theta\right)} = \frac{\sin^2\left(\frac{\pi}{\lambda}w\theta\right) \cdot \sin^2\left(\frac{\pi}{\lambda}nd\theta\right)}{\frac{\pi^2\theta^2}{\lambda^2} \cdot \sin^2\left(\frac{\pi}{\lambda}d\theta\right)}$$

6 Downloads

- [1] The measured data (tables and plots, zipped Excel files):
<http://goliat.eik.bme.hu/~vanko/wfphc/measure.zip>
- [2] The simulation based on the phasor representation (zipped Excel file):
<http://goliat.eik.bme.hu/~vanko/wfphc/simulate.zip>
- [3] The presentation held on the 17th April 2004 on the Second Congress of the World Federation of Physics Competitions, Paterswolde, The Netherlands, 14-18 April 2004 (zipped PowerPoint file):
<http://goliat.eik.bme.hu/~vanko/wfphc/presentation.zip>